

Features:

- 768Mb/s to 5Gb/s duplex data links
- Compliant to 802.3z Ethernet, Fibre Channel (1x/2x/4x), Infiniband, sFPDP, XAUI, FCAV and ARINC 818
- ATEX and IECEx certified configuration available
- 850 nm VCSEL laser transmitter and PIN receiver
- Typical reach of 500 m on 50/125 and 250 m on 62.5/125 µm MMF
- Duplex LC or Dual ARINC-801 connector options
- Optional Digital Diagnostics per SFF 8472
- MIL-STD-883 certified
- -40 to +85°C operating temperature standard, -55 to +95°C option
- Option for RoHS 6/6 compliant and lead free per Directive 2011/65/EU
- Single +3.3V power supply
- AC-Coupled Transmitter & Receiver Data

NOTE: Not recommended for new designs.

- The RJ-5G-SX-C is recommended for forward compatibility with 10G RJ transceivers

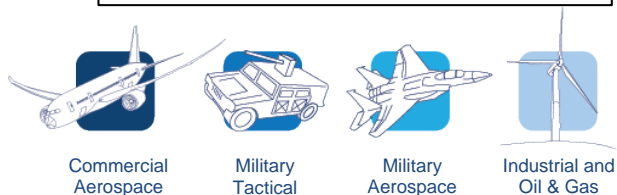
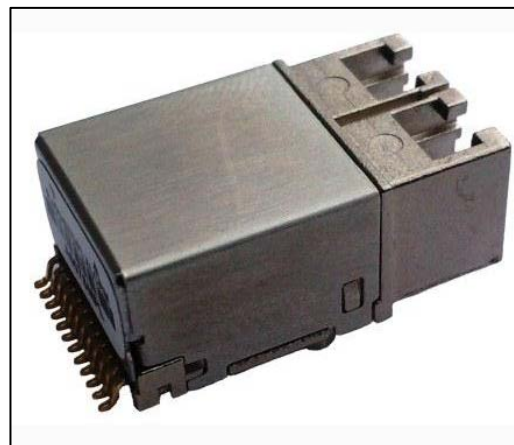

The RJ-5G-SX is ideal for harsh environment connectivity because of its low cost, availability and wide operating parameters.

Absolute Maximum Ratings

PARAMETER	SYMBOL	MIN.	MAX.	UNIT	NOTES
Maximum Supply Voltage	V _{CC}	-0.3	4.0	V	
Storage Temperature	T _{sto}	-55	105	°C	
Operating Temperature	T _{OP}	-40	85	°C	-55°C to 95°C option available
Relative Humidity	RH	0	85	%	Based on conformal coating (1)
Hot Bar Soldering Temperature			260	°C	10 seconds, leads only, (2)(3)
Hand Lead Soldering Temperature			260	°C	10 seconds, leads only, (2)(3)
Conformal Coating		0.8	1.2	mil	See ruggedization notes

Notes:

- 1) RJ transceivers may be water washed. The process must be followed by an 80°C bake for one hour to ensure the drying of any water inside the shell.
- 2) For optional solder post version, solder posts are intended for mechanical retention only and do not have to comply fully to IPC J-STD-001 Class 3
- 3) The components should not undergo Reflow Soldering under any circumstances.

General Specifications

PARAMETER	SYMBOL	MIN.	TYP.	MAX.	UNIT	NOTES
Data Rate	BR	0.768		5	Gb/s	8b10b encoding

Electrical Specifications (T_{OP} = -40 to 85°C, V_{CC} = 3.14 to 3.47 Volts)

PARAMETER	SYMBOL	MIN.	TYP.	MAX.	UNIT	NOTES
Supply Voltage	V _{CC}	3.14	3.3	3.47	V	
Total Module Power Dissipation	P _{DISS}			0.83	W	
Total Supply Current (Tx + Rx)	I _{CC}			240	mA	
Transmitter						
Supply Current	I _{CC}			120	mA	
Input differential impedance	R _{in}	90	100	110	Ω	LVPECL
Tx Common Mode Voltage	V _{ICM}		2.0		V	CML
Single-Ended Input Voltage Swing	V _{DTX}	100		1200	mV	CML
Transmit Disable Voltage	V _D	1.8		V _{CC}	V	LVTTTL
Transmit Enable Voltage	V _{EN}	-0.3		0.8	V	LVTTTL
Receiver						
Supply Current	I _{CC}		85	120	mA	
Single-Ended Output Voltage Swing	V _{DRX}	100	300	500	mV	CML
Signal Detect Assert	SD _{norm}	V _{CC} -0.5		V _{CC}	V	LVTTTL
Signal Detect De-assert	SD _{fault}	0		0.4	V	LVTTTL
Deterministic Jitter Contribution	RX Δ DJ			0.10	UI	(1)
Total Jitter Contribution (p-p)	RX Δ TJ			0.16	UI	(2)
Notes:						
1) Measured running 4.25 Gb/s, K28.5 test pattern						
2) Measured running 4.25 Gb/s, PRBS 2 ⁷ -1 data						

Pin Configuration

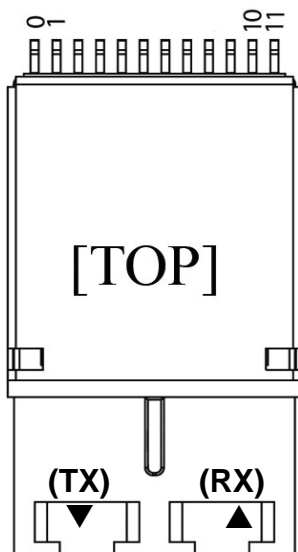

PIN #	Symbol	Description	Logic/ Protocol	Notes
0	SCL	2-Wire Interface Clock	I2C	(1)
1	TD+	Transmitter DATA In +	CML	
2	V _{EET}	Transmitter Signal Ground	0V	
3	TD-	Transmitter DATA In -	CML	
4	V _{CCT}	Transmitter Power Supply	3.3V	
5	SD	Signal Detect output Satisfactory Optical Input: Logic "1" Output Fault Condition: Logic "0" Output	LVTTTL	
6	T _{DIS}	Transmit Disable input Logic 1 = Disable Optical Output Logic 0 = Enable Optical Output Internal 10K ohm pull-down (enable)	LVTTTL	
7	RD+	Receiver DATA Out +	CML	
8	V _{CCR}	Receiver Power Supply	3.3V	
9	RD-	Receiver DATA Out -	CML	
10	V _{EER}	Receiver Signal Ground	0V	
11	SDA	2-Wire Interface Data	I2C	(1)

Notes:

- 1) Pins 0 and 11 are the 2-wire bus pins for the digital diagnostics option
- 2) Pins: phosphor bronze 510 spring temper with 10 micro-inch of gold. Body is Vectra E130i
- 3) The RJ-5G-SX is not recommended for new designs.
 - a. The RJ-5G-SX-C should be utilized in new designs to ensure forward compatibility with COTSWORKS' 10G RJ transceiver pinout configuration

Optical Characteristics (T_{OP} = -40 to 85°C, V_{CC} = 3.14 to 3.47 Volts)

PARAMETER	SYMBOL	MIN.	TYP.	MAX.	UNIT	NOTES
Transmitter						
Optical Output Power	P _{OUT}	-5		-1	dBm	(1)(4)
Optical Output Power	P _{OUT}	-7		-1	dBm	(1)(3)(4)
Optical Wavelength	λ	840	850	860	nm	(2)
RMS Spectral Width	σ			.85	nm	(2)
Extinction Ratio	ER	6			dB	(2)(3)
Optical Rise Time	t _r			90	ps	Unfiltered 20% - 80%, (1)(2)
Optical Fall Time	t _f			125	ps	
Relative Intensity Noise	RIN			-117	dB/Hz	
Deterministic Jitter Contribution	TX Δ DJ			0.12	UI	(6)
Total Jitter Contribution (p-p)	TX Δ TJ			0.40	UI	(2)
Receiver						
Sensitivity: 5 Gb/s	RX _{SENS5}			-14	dBm	(5)
Sensitivity: 4.25 Gb/s	RX _{SENS4}			-16	dBm	
Sensitivity: 3.00 Gb/s	RX _{SENS3}			-16	dBm	
Sensitivity: 2.125 Gb/s	RX _{SENS2}			-18	dBm	
Sensitivity: 1.25 Gb/s	RX _{SENS1}			-21	dBm	
Sensitivity: 768 Mb/s	RX _{SENS0}			-18	dBm	
Overload	RX _{MAX}			0	dBm	
Optical Center Wavelength	λ_c	840		860	nm	
Return Loss	RL	12			dB	
Signal Detect Assert: 5.00 Gb/s	P _{A5}			-14	dBm	
Signal Detect Assert: 4.25 Gb/s	P _{A4}			-15	dBm	
Signal Detect Assert: 3.00 Gb/s	P _{A3}			-16	dBm	
Signal Detect Assert: 2.125 Gb/s	P _{A2}			-17	dBm	
Signal Detect Assert: 1.25 Gb/s	P _{A1}			-20	dBm	
Signal Detect Assert: 768 Mb/s	P _{A0}			-19	dBm	
Signal Detect De-Assert	P _D	-29			dBm	All data rates
Signal Detect Hysteresis	P _A - P _D	1		5	dB	

Notes:

- 1) Measured at the end of a 2m to 5m 62.5 μ m multi-mode fiber patch cord
- 2) Measured running 4.25 Gb/s, PRBS 2⁷-1 data
- 3) Applicable between the extended temperature ranges of -55°C to -40°C and 85°C to 95°C
- 4) Class 1 Laser Safety per FDA/CDRH and IEC-825-1 regulations
- 5) Measured using PRBS 2⁷-1 pattern
- 6) Measured running 4.25 Gb/s, K28.5 test pattern

Digital Diagnostics Information

The COTSWORKS RJ module is available with optional signal pins for a 2-wire bus required to access digital diagnostics compliant to SFF 8472 multi-source agreement. The transceiver pinout (including those pins required for 2-wire communication to access the digital diagnostics) is shown on page 2 of this document.

Application Schematics

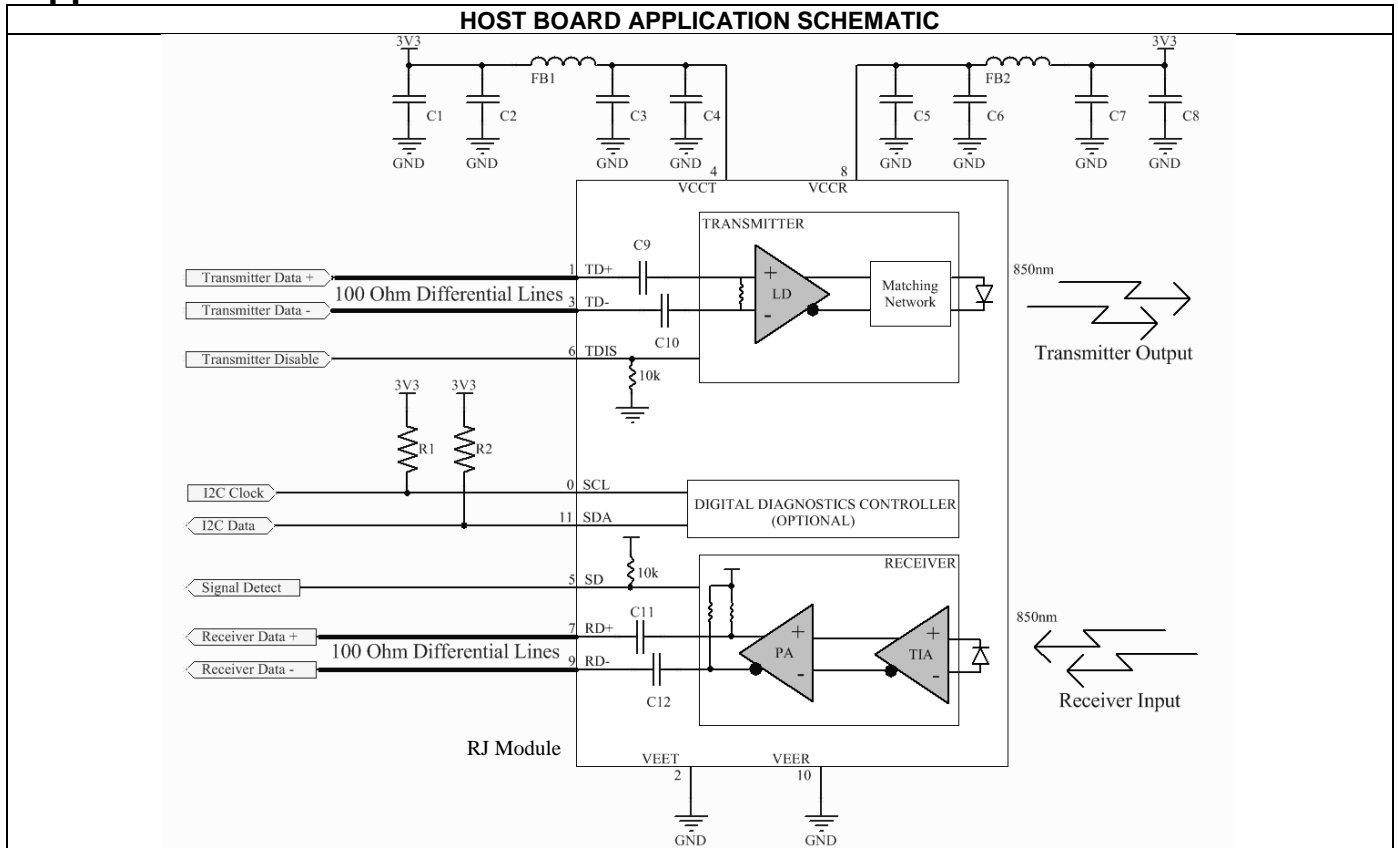

Notes:

- Recommend host routes separate supply voltages and filtering for RJ-module transmitter and receiver as shown in the schematic above:
 - FB1/FB2 ferrite bead for power supply noise suppression; Murata BLM18KG601SN1, 0603, 600Ω @ 100MHz, 1300mA .
 - C1/C4/C5/C8 bulk capacitance; Murata GRM21BR61C106KE15L, 0805, 10μF, 16V.
 - C2/C3/C6/C7 de-coupling capacitors; Murata GRM155R71C104KA88D, 0402, 0.1μF, 16V.
- R1/R2 2-wire bus pull-up resistors required on host for implementing optional digital diagnostics; 4.7kΩ to 10kΩ.
- Screw or solder posts are not internally connected to signal ground. Recommend screw or solder posts be connected to chassis ground if available, otherwise they should be tied to local signal ground.
- For host with LVPECL electrical interface contact COTSWORKS' applications engineering.

TRANSMITTER EQUIVALENT INPUT CIRCUIT

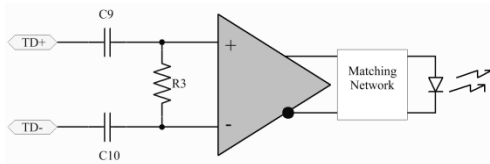

- C9/C10 0.1μF internal input data coupling capacitors.
- R3 internal 100Ω input differential termination.
- Transmitter electrical input is CML compatible.

RECEIVER EQUIVALENT OUTPUT CIRCUIT

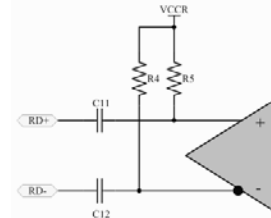

- C11/C12 are 0.1μF output data coupling capacitors.
- R4/R5 are 50Ω pull-up resistors to Vcc.
- Receiver electrical output is CML compatible.

PCB Design Guidelines

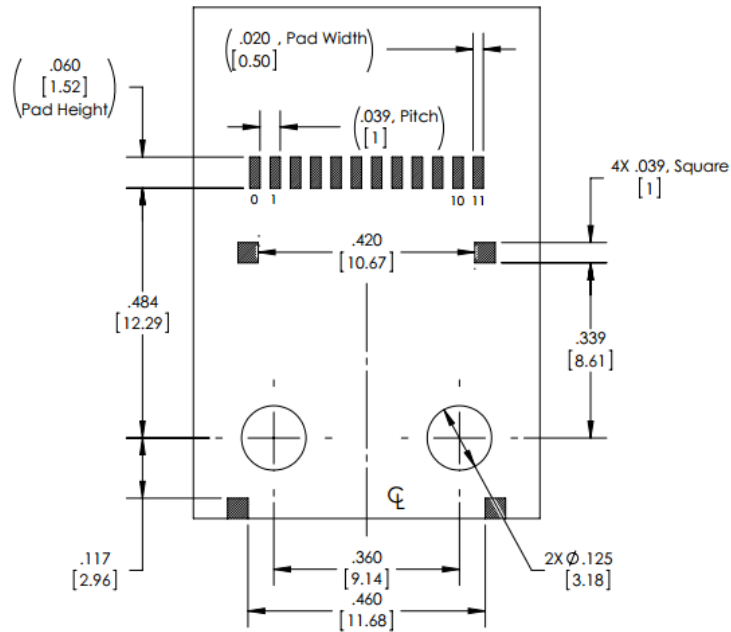

Notes:

1) Pads 0 and 11 are the 2-wire bus signal pin pads for the digital diagnostics option

Panel Cutout

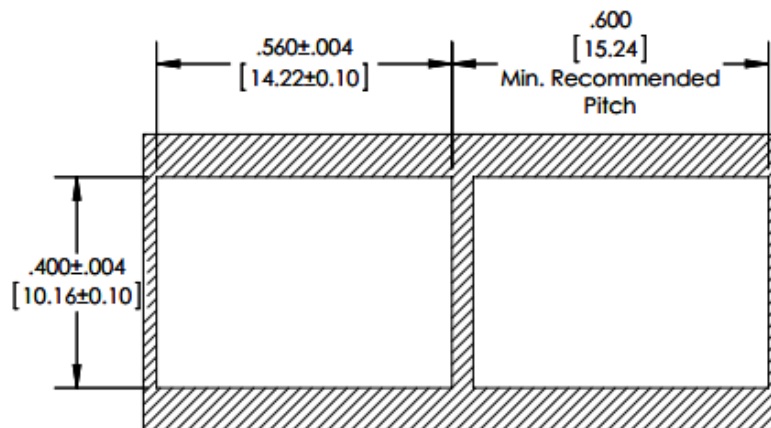

LC Connector [Screw Post] Mechanical Dimensions

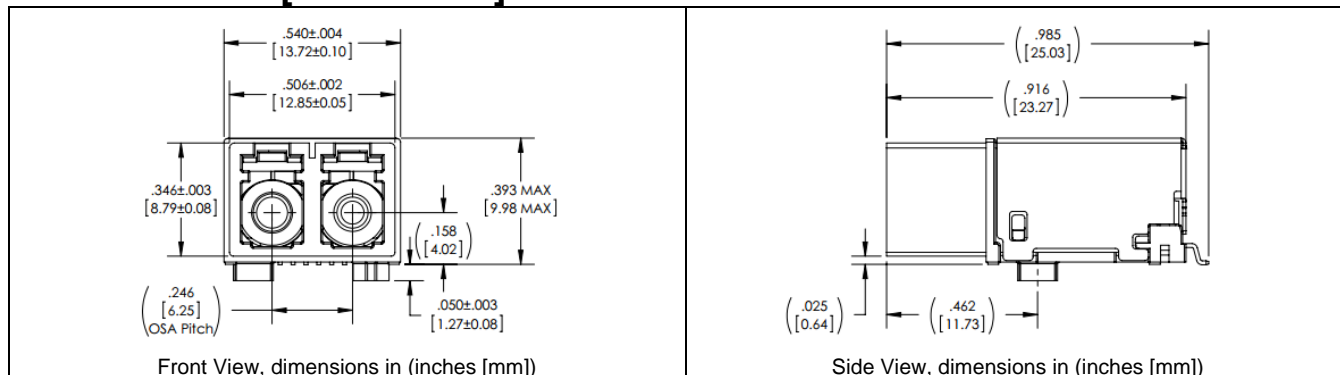

LC Connector [Solder Post] Mechanical Dimensions

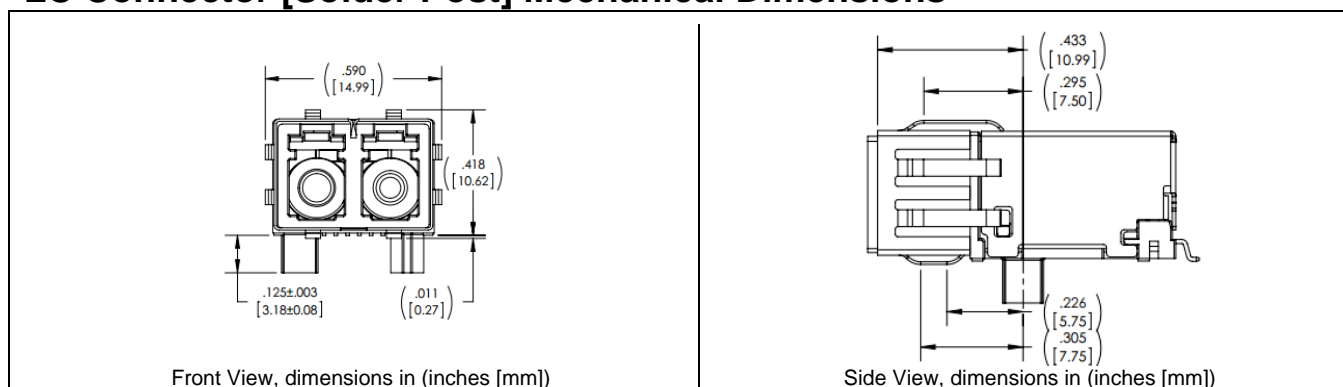

ARINC-801 Connector [Screw Post] Mechanical Dimensions

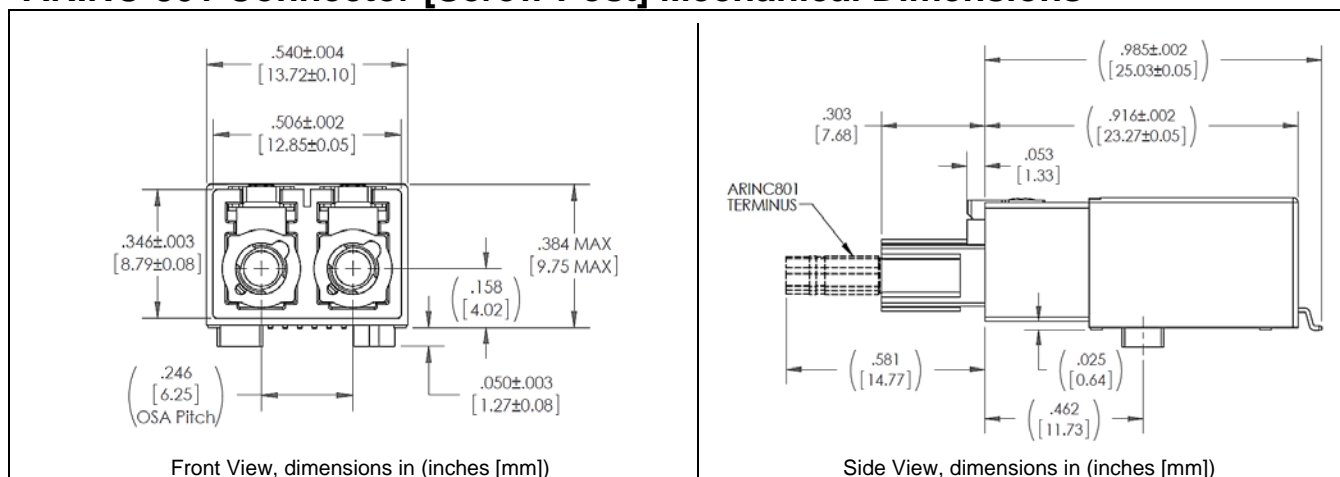

Mounting Hardware Guidelines

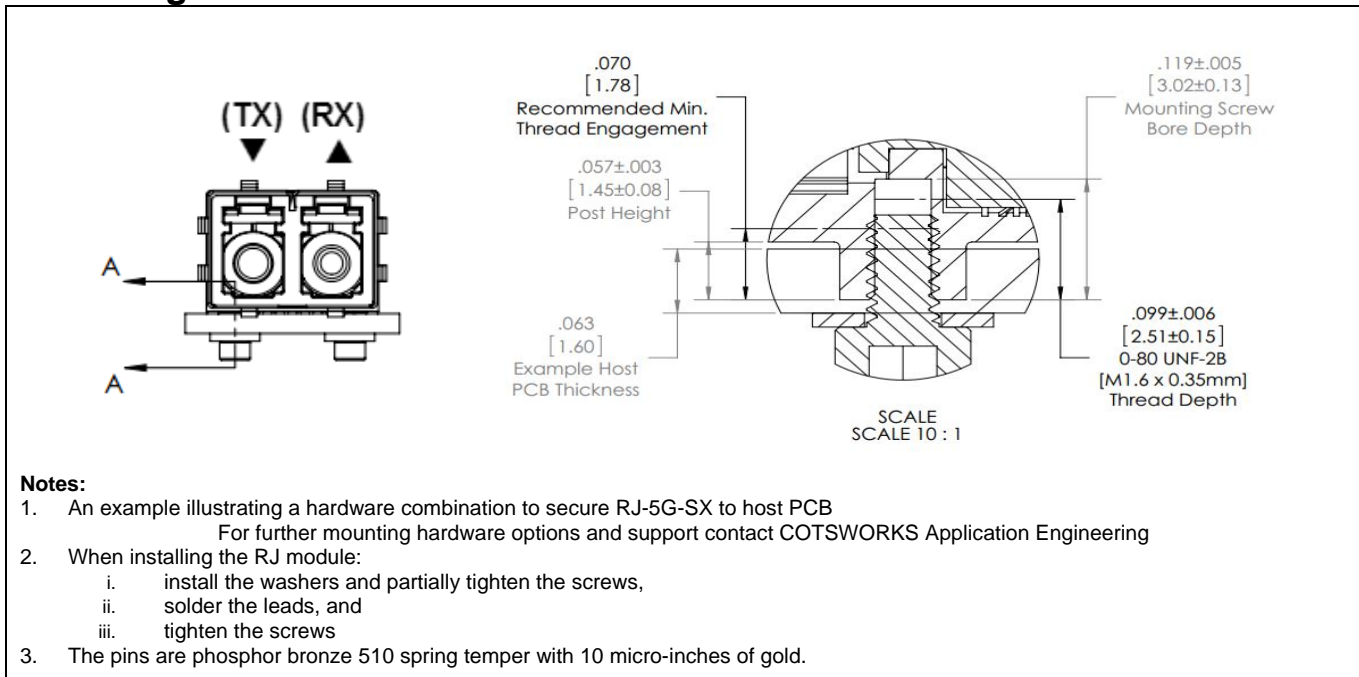

Ruggedization Notes

- Parylene C coating can be used for conformal coating with a 1.0 mil ± 0.2 mil thickness through a deposition process
 - It has a 5600 VPM rating, withstands high temperatures, extremely resistant to oil/dirt, and object impact
- This part is also available in a pigtail fiber optic version. Contact COTSWORKS for available fiber and termini options.
- Transceiver case is nickel-plated

Reference Information

- 1) IEEE Standard 802.3, 2002 Edition
- 2) Directive 2011/65/EU of the European Parliament and of the Council, "on the restriction of the use of certain hazardous substances in electrical and electronic equipment." June 8th, 2011

Regulatory Compliance

- COTSWORKS transceivers are Class 1 Laser Products and designed to comply with US FDA regulations.
- These products are designed to comply with Class 1 eye safety requirements of EN (IEC) 60825 and the electrical safety requirements of EN (IEC) 60950.
- This part has an option for compliance with Directive 2011/65/EU covering restriction on certain hazardous substances (RoHS)
 - Contact COTSWORKS support for a product compliance matrix

Warnings:

Handling Precautions: This device is susceptible to damage as a result of electrostatic discharge (ESD). A static free environment is highly recommended.

Laser Safety: Radiation emitted by laser devices can be dangerous to human eyes. Avoid eye exposure to direct or indirect radiation.

Ordering Information

RJ-5G-SX	-x-	DPLX-xx-	x	-x-	x	-x-	x	-x
RJ Form Factor	Pins & Diagnostics	Receptacle Type	Ruggedized Coating	Operating Temp (°C)	EMI Shield?	RoHS Level	Mounting	ATEX & IECEx Cert.
5 Gbps Max Data Rate	(): 1x10 No DDMI	LC: LC Receptacle	(): Non-coated	A: -40 to 85	(): No Shield	(): Lvl 5	(): Imperial	T: Certified
(MMF)	D: 1x12 DDMI	LX: ARINC-801 Receptacle	R: Parylene	M: -40 to 95	E: Shield	6 Lvl 6	U: Metric	(): Not Certified
				Z: -55 to 95			P: Solder Posts	

Example part number: RJ-5G-SX-D-DPLX-LX-R-A
 [5G RJ Form Factor Transceiver, 850nm, digital diagnostics,
 Duplex ARINC-801 connectors, Parylene-coated, industrial operating temp range, Imperial Screw Posts]

NOTE: The RJ-5G-SX is not recommended for new designs.
 The RJ-5G-SX-C should be utilized in new designs to ensure forward compatibility with the
 COTSWORKS 10G RJ transceiver pinout configuration.
 Please refer to the COTSWORKS RJ-5G-SX-C datasheet for more information.

COTSWORKS and the COTSWORKS logo are registered trademarks of COTSWORKS, LLC.
 COTSWORKS reserves the right to change, alter, or revise this document without notice unless otherwise agreed to.